

**SHURE**

# MICROFLEX<sup>®</sup> MICROPHONES



## THERE'S NEVER BEEN A MORE FLEXIBLE CHOICE.

Work a room in more ways than ever with Shure Microflex microphones. Combining sleek, low profile aesthetics and a complete selection of microphones and mounting options, the Microflex line offers the highest standard of quality and efficiency for installed audio applications.

### MICROFLEX GOOSENECK MICROPHONES

- Models in lengths from 12-62 cm (5-24 inches) fit a wide variety of applications from the podium to the conference table
- Interchangeable condenser cartridges with superior audio quality

### MICROFLEX BOUNDARY MICROPHONES

- Multi-element, low-profile, or wireless microphone styles available
- Extremely versatile range of placement options for easy configuration and installation

### MICROFLEX OVERHEAD MICROPHONES

- Compact and adjustable 10 cm (4") gooseneck
- Interchangeable condenser cartridges for accurate sound reproduction in any setting

### MICROFLEX LAVALIER AND EARSET MICROPHONES

- For applications requiring low-profile discreet placement
- Use in wired or wireless applications

## APPLICATIONS

Conference Rooms

Seminars

Houses of Worship

Theaters

Courtrooms

Lecterns

## PRODUCT HIGHLIGHTS

Wide selection for customized installations

Wired or wireless models available

Superior audio quality

CommShield™ Technology for improved RF resistance

Sleek, low-profile designs

**SHURE**

# MX405, MX410, MX415 MODULAR GOOSENECK MICROPHONES

Flexible in more ways than one, Microflex Modular Gooseneck Microphones deliver unsurpassed style and performance for conference rooms and similar applications. Offering desktop or mounted bases, wired or wireless options, and even interchangeable cartridges, it's easy to get the perfect fit for your application. Fully compatible with Microflex Wireless Systems and ULX-D Systems.

## Specifications

<b>Type</b>	Condenser (electret bias)
<b>Frequency Response</b>	50 Hz – 17 kHz
<b>Polar Pattern</b>	MX405/C, MX410/C, MX415/C: Cardioid MX405/S, MX410/S, MX415/S: Supercardioid MX405/MS Lobar Mini-Shotgun
<b>Output Impedance</b>	EIA rated at 150 Ω (170 Ω actual)
<b>Output Configuration</b>	Active balanced
<b>Sensitivity</b> at 1 kHz, open circuit voltage; 1 Pascal = 94 dB SPL	Cardioid: -35 dBV/Pa (18 mV) Supercardioid: -34 dBV/Pa (21 mV) Lobar: -33 dBV/Pa (22 mV)a
<b>Maximum SPL</b> 1 kHz at 1% THD, 1 kΩ load	Cardioid: 121 dB Supercardioid: 120 dB Lobar: 121 dB SPL
<b>Equivalent Output Noise A-weighted</b>	Cardioid: 28 dB SPL Supercardioid: 27 dB SPL Lobar: 36 dB
<b>Signal-to-Noise Ratio</b> referenced at 94 dB SPL at 1 kHz	Cardioid: 66 dB Supercardioid: 67 dB Lobar: 68 dB
<b>Dynamic Range</b> 1 kΩ load at 1 kHz	93 dB
<b>Common Mode Rejection</b> 10 Hz to 100 kHz	45 dB minimum
<b>Preamplifier Output Clipping Level</b> 1% THD	-8 dBV (0.4 V)
<b>Polarity</b>	3-Pin XLR: Positive sound pressure on diaphragm produces positive voltage on pin 2 relative to pin 3 of output XLR connector. 5-Pin XLR: Positive sound pressure on diaphragm produces positive voltage on pin 4 relative to pin 2 of output XLR connector.
<b>Weight</b>	MX405: 54 g MX410: 68 g MX415: 70 g MX400DP: 516 g MX400SMP (w/ Kit): 125 g
<b>Logic Connections</b>	LED IN: Active low (<math>\leq 1.0\text{ V}</math>), TTL compatible. Absolute maximum voltage: -0.7 V to 50 V. LOGIC OUT: Active low (<math>\leq 1.0\text{ V}</math>), sinks up to 20 mA, TTL compatible. Absolute maximum voltage: -0.7 V to 50 V (up to 50 V through 3 kΩ).
<b>Mute Switch Attenuation</b>	-50 dB minimum
<b>Cable</b>	MX400DP: 6 m attached cable with shielded audio pair terminated at a 3-pin male XLR and three unterminated conductors for logic control
<b>Environmental Conditions</b>	Operating temperature: -18 – 57 °C Storage temperature: -29 – 74 °C Relative humidity: 0 – 95%
<b>Power Requirements</b>	48 – 52 Vdc phantom, 8.0 mA

\*for detailed dimensions please reference MX405/410/415 user guide

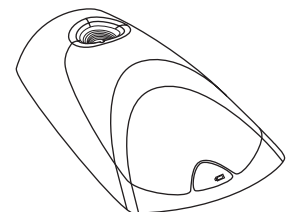
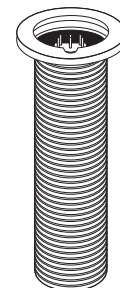
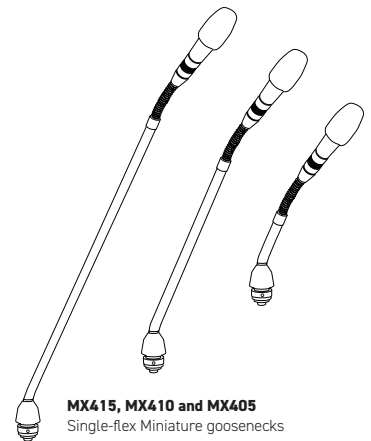

## Available Models

The polar pattern of the cartridge is indicated by the model number suffix: C = Cardioid, S = Supercardioid, N = No Cartridge, MS = Lobar

<b>MX405/N, MX405/C, MX405/S, MX405/MS</b>	127 mm (5 inch) gooseneck, bi-color status indicator, includes surface mount preamp
<b>MX405R/N, /C, /S, /MS</b>	127 mm (5 inch) gooseneck, light ring, includes surface mount preamp
<b>MX410/C, /S</b>	254 mm (10 inch) gooseneck, bi-color status indicator, includes surface mount preamp
<b>MX410R/N</b>	254 mm (10 inch) gooseneck, light ring, includes surface mount preamp
<b>MX415/C, /S</b>	381 mm (15 inch) gooseneck, bi-color status indicator, includes surface mount preamp
<b>MX415R/N</b>	381 mm (15 inch) gooseneck, light ring, includes surface mount preamp
<b>MX405LP/N, /C, /S, /MS</b>	127 mm (5 inch) gooseneck, bi-color status indicator, less preamp
<b>MX405RLP/N, /C, /S, /MS</b>	127 mm (5 inch) gooseneck, light ring, less preamp
<b>MX405WLP/N</b>	127 mm (5 inch) gooseneck, bi-color status indicator, less preamp, white
<b>MX405WRP/N</b>	127 mm (5 inch) gooseneck, light ring, less preamp, white
<b>MX410LP/C, /S</b>	254 mm (10 inch) gooseneck, cardioid, bi-color status indicator, less preamp
<b>MX410RLP/N</b>	254 mm (10 inch) gooseneck, light ring, less preamp
<b>MX410LPDF/C, /S</b>	254 mm (10 inch) gooseneck, bi-color status indicator, less preamp, dualflex
<b>MX410RLPDF/C, /S</b>	254 mm (10 inch) gooseneck, light ring, less preamp, dualflex



# MX405, MX410, MX415 MODULAR GOOSENECK MICROPHONES

## Available Models (Continued)

The polar pattern of the cartridge is indicated by the model number suffix: C = Cardioid, S = Supercardioid, N = No Cartridge, MS = Lobar

<b>MX410RLPDF/N</b>	254 mm (10 inch) gooseneck, light ring, less preamp, dualflex
<b>MX410WLP/N</b>	254 mm (10 inch) gooseneck, light ring, less preamp, Dualflex, white
<b>MX415LP/C, /S</b>	381 mm (15 inch) gooseneck, cardioid, bi-color status indicator, less preamp
<b>MX415RLP/N</b>	381 mm (15 inch) gooseneck, light ring, less preamp
<b>MX415LPDF/C, /S</b>	381 mm (15 inch) gooseneck, bi-color status indicator, less preamp, dualflex
<b>MX415RLPDF/C, /S</b>	381 mm (15 inch) gooseneck, light ring, less preamp, dualflex
<b>MX415RLPDF/N</b>	381 mm (15 inch) gooseneck, light ring, less preamp, dualflex

## Optional Accessories and Replacement Parts

<b>MX400SMP</b>	Surface mount preamp	<b>R184B</b>	Black supercardioid cartridge for all Microflex models	<b>R189B</b>	Black lobar mini-shotgun cartridge for black Microflex models
<b>MX400DP</b>	Wired desktop base. Includes 6.1 m attached cable	<b>R183B</b>	Black Omnidirectional cartridge for all Microflex models	<b>R183W-A</b>	White Omnidirectional cartridge for all white Microflex models
<b>R185W-A</b>	White cardioid cartridge for all white Microflex models	<b>R184W-A</b>	White Supercardioid cartridge for all white Microflex models	<b>A400MB</b>	Mute Button Accessory
<b>R189W-A</b>	White Lobar cartridge for all white Microflex models	<b>A412MWS</b>	Metal locking windscreen	<b>A400MB-MOUNT</b>	Remote Mounting Kit for A400MB
<b>R185B</b>	Black cardioid cartridge for all Microflex models	<b>95A2487</b>	Tapered windscreen		

## Furnished Accessories

### Models with included Preamp

<b>MX400SMP</b>	Surface mount preamp
<b>65A405</b>	Rubber isolation rings
<b>65A2190</b>	Wing nut
<b>95A2529</b>	5-pin XLR-F
<b>65A2166</b>	Cap

### All Models

<b>RK513WS</b>	Black snap-fit foam windscreen (4 pcs.)	<b>A189WWS-A</b>	White flocked snap-fit foam minishotgun windscreen
<b>RK514</b>	White snap-fit foam windscreen (4 pcs.)	<b>A189BWS</b>	Black minishotgun windscreen
<b>A410WWS-A</b>	White flocked snap-fit foam windscreen	<b>A189WWS</b>	White mini-shotgun windscreen

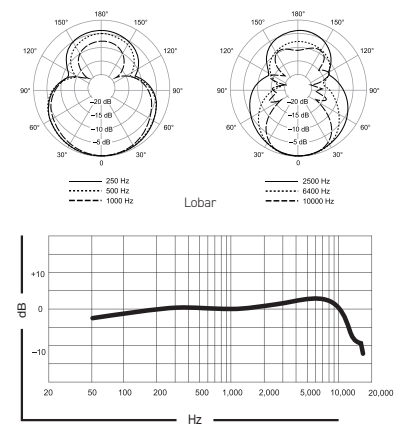
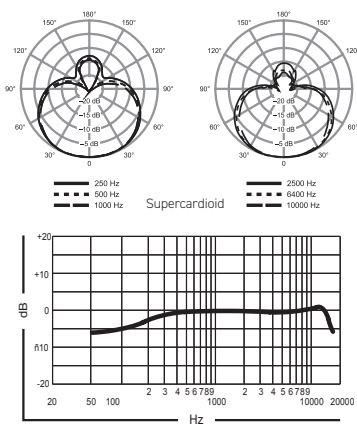
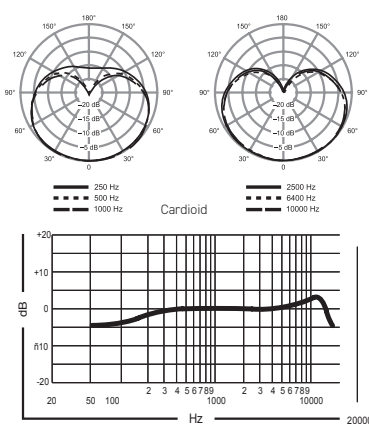

# MX412, MX418, MX424 STANDARD GOOSENECK MICROPHONES

Microflex Standard Gooseneck Microphones provide the added length and flexibility needed for speakers in environments like lecterns, pulpits, and courtrooms. Available in four models with a variety of lengths and mounting styles to choose from, Microflex Gooseneck microphones feature high sensitivity and balanced, transformerless output for maximum resistance to electromagnetic hum and RF interference, even over long cable runs.

## Specifications

<b>Type</b>	Condenser (electret bias)
<b>Frequency Response</b>	50 Hz – 17 kHz
<b>Polar Pattern</b>	MX412/C, MX418/C, MX424/C: Cardioid MX412/S, MX418/S, MX424/S: Supercardioid Omnidirectional cartridge available separately
<b>Output Impedance</b>	EIA rated at 150 Ω (170 Ω actual)
<b>Sensitivity</b> at 1 kHz, open circuit voltage; 1 Pascal = 94 dB SPL	Cardioid: -35 dBV/Pa (17.8 mV) Supercardioid: -33.5 dBV/Pa (21.1 mV) Omnidirectional: -27.5 (42.2 mV)
<b>Maximum SPL</b> 1 kHz at 1% THD, 1 kΩ load	Cardioid: 124.2 dB Supercardioid: 122.7 dB Omnidirectional: 116.7 dB
<b>Equivalent Output Noise</b> A-weighted	Cardioid: 28 dB SPL Supercardioid: 26.5 dB SPL Omnidirectional: 20.5 dB SPL
<b>Signal-to-Noise Ratio</b> referenced at 94 dB SPL at 1 kHz	Cardioid: 66 dB Supercardioid: 67.5 dB Omnidirectional: 73.5 dB
<b>Dynamic Range</b> 1 kΩ load at 1 kHz	96.2 dB 100 dB at 0 gain (internal modification)
<b>Common Mode Rejection</b>	45 dB minimum (10 Hz – 100 kHz)
<b>Preamplifier Output Clipping Level</b> 1% THD	-6 dBV (0.5 V)
<b>Polarity</b>	Positive sound pressure on diaphragm produces positive voltage on pin 2 relative to pin 3 of output XLR connector.
<b>Mute Switch Attenuation</b>	-50 dB minimum
<b>Cable</b>	MX412D and MX418D: The 3 m attached custom cable contains a shielded audio pair and three unshielded conductors for logic control. Overall diameter = 4 mm
<b>Environmental Conditions</b>	Operating temperature range: -18° – 57° C Relative humidity: 0 – 95%
<b>Power Requirements</b>	11 – 52 Vdc phantom, 8.0 mA

\*for detailed dimensions please reference MX412/418/424 user guides



**MX412, MX418 and MX424**  
Standard Gooseneck Microphones

## Available Models

The polar pattern of the cartridge is indicated by the model number suffix: C = Cardioid, S = Supercardioid, N = No Cartridge

<b>MX412/C, MX412/S, MX412/N</b>	331 mm (13 inch) gooseneck, attached XLR preamp, shock mount, flange mount, snap-fit foam windscreen
<b>MX418/C, MX418/S, MX418/N</b>	473 mm (19 inch) gooseneck, attached XLR preamp, shock mount, flange mount, snap-fit foam windscreen
<b>MX412S/C, MX412S/S, MX412S/N</b>	334 mm (13 inch) gooseneck, attached XLR preamp, shock mount, flange mount, snap-fit foam windscreen, mute switch, LED Indicator
<b>MX418S/C, MX418S/S, MX418S/N</b>	473 mm (19 inch) gooseneck, attached XLR preamp, shock mount, flange mount, snap-fit foam windscreen, mute switch, LED indicator
<b>MX412SE/C, MX412SE/S, MX412SE/N</b>	305 mm (12 inch) gooseneck, in-line preamp, shock mount, flange mount, 3 m side-exit (or bottom-exit) cable, snap-fit foam windscreen
<b>MX418SE/C, MX418SE/S, MX418SE/N</b>	457 mm (18 inch) gooseneck, in-line preamp, shock mount, flange mount, 3 m side-exit (or bottom-exit) cable, snap-fit foam windscreen
<b>MX412D/C, MX412D/S, MX412D/N</b>	305 mm (12 inch) gooseneck, desktop base with 3 m cable, logic functions, programmable switch and LED indicator, snap-fit foam windscreen
<b>MX418D/C, MX418D/S, MX418D/N</b>	457 mm (18 inch) gooseneck, desktop base with 3 m cable, logic functions, programmable switch and LED indicator, snap-fit foam windscreen
<b>MX424/C, MX424/S, MX424/N</b>	623 mm (25 inch) gooseneck, attached XLR preamp, shock mount, flange mount, snap-fit foam windscreen

# MX412, MX418, MX424 STANDARD GOOSENECK MICROPHONES

## Furnished Accessories

MX412, MX418, MX412S, MX418S, MX424 Models		MX412SE, MX418SE Models		MX412D, MX418D Models	
<b>65B8264</b>	Flange	<b>A12C</b>	Flange and nut	<b>RK412WS</b>	Snap-fit foam windscreen (1 furnished, 4 in replacement pack)
<b>65B8265</b>	Retainer	<b>80A476</b>	Clamp		
<b>80A439</b>	Isolation ring	<b>A400SM</b>	Shock mount		
<b>RK412WS</b>	Snap-fit foam windscreen (1 furnished, 4 in replacement pack)	<b>RK412WS</b>	Snap-fit foam windscreen (1 furnished, 4 in replacement pack)		
<b>A400SM</b>	Shock mount	<b>31B1762A</b>	Shock mount adapter		
<b>80A67</b>	Hex wrench #4				

## Optional Accessories and Replacement Parts

<b>A412B</b>	Desktop base	<b>C130</b>	Custom logic cable (specify length)	<b>R185B</b>	Black cardioid cartridge for all Microflex models
<b>A412MWS</b>	Metal locking windscreen	<b>RK100PK</b>	Replacement in-line preamplifier (SE models)	<b>R189B</b>	Black lobar mini-shotgun cartridge for Microflex models
<b>A99WS</b>	Foam ball windscreen	<b>R183B</b>	Black omnidirectional cartridge for all Microflex models		
<b>A57F</b>	Stand adapter	<b>R184B</b>	Black supercardioid cartridge for all Microflex models		

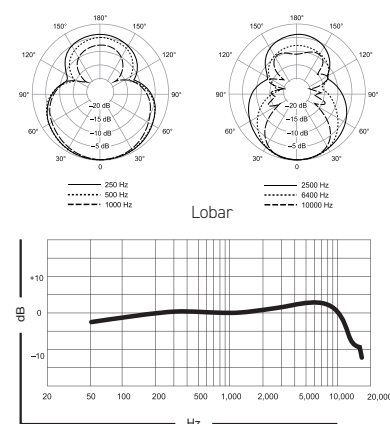
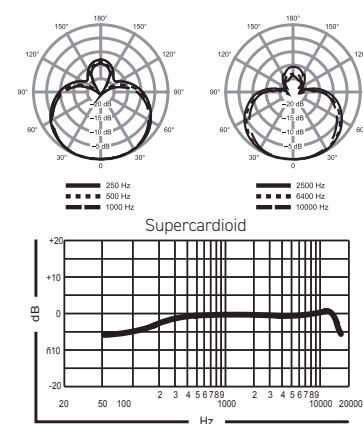
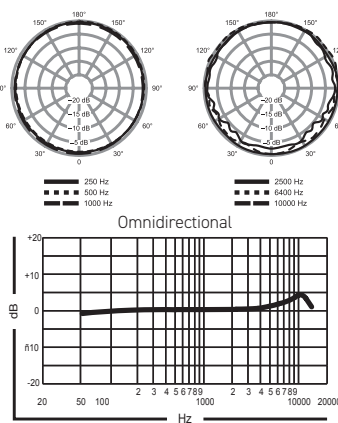
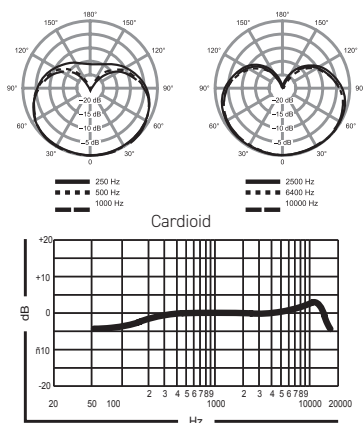

# MX415DUAL /C DUAL CAPSULE GOOSENECK MICROPHONE

The MX415DUAL/C microphone features two cardioid condenser cartridges mounted in a single low-profile housing and two preamp-equipped outputs providing redundant audio for critical, multi-feed live sound and professional broadcast applications. The microphone has a 15" overall length and equipped with a flexible top gooseneck section for optimal placement.

## Specifications

<b>Type</b>	Condenser (electret bias)
<b>Frequency Response</b>	50 Hz - 17 kHz
<b>Polar Pattern</b>	Cardioid
<b>Output Impedance</b>	EIA rated at 160 Ω
<b>Sensitivity</b> at 1 kHz, open circuit voltage; 1 Pascal = 94 dB SPL	-35 dBV/Pa (17.8 mV)
<b>Maximum SPL</b> 1 kHz at 1% THD, 1 kΩ load	124.2 dB
<b>Equivalent Output Noise</b> A-weighted	28 dB SPL
<b>Signal-to-Noise Ratio</b> referenced at 94 dB SPL at 1 kHz	66 dB
<b>Dynamic Range</b> 1 kΩ load at 1 kHz	96.2 dB 100 dB at 0 gain (internal modification)
<b>Common Mode Rejection</b>	45 dB minimum (10 Hz - 100 kHz)
<b>Preamplifier Output Clipping Level</b> 1% THD	-6 dBV (0.5 V)
<b>Polarity</b>	Positive sound pressure on diaphragm produces positive voltage on pin 2 relative to pin 3 of output XLR connector.
<b>Cable</b>	Dual attached 5-foot bottom exit cables terminated with TA4F connectors
<b>Environmental Conditions</b>	Operating temperature range: -18° - 57° C Relative humidity: 0 - 95%
<b>Power Requirements</b>	11 - 52 Vdc phantom, 8.0 mA

\*for detailed dimensions please reference MX415DUAL/C user guides



**MX415DUAL/C**  
Dual Capsule Gooseneck Microphone

## Available Models

<b>MX415DUAL/C</b>	381 mm (15 inch) gooseneck, attached dual 152 cm (5 ft) cable with dual TA4F connectors.
--------------------	--

## Furnished Accessories

<b>A57F</b>	Mic Swivel Adapter
<b>A26X</b>	Extension Tube
<b>A13HDB</b>	Mounting Flange
<b>RPM640</b>	Locking Mounting Flange
<b>A400SM</b>	Shock Mount
<b>RK100PK</b>	Inline Preamps (2)
<b>RPM40PREMNT</b>	Preamp Mounting Plates (2)
<b>RK415DWS</b>	Snap Fit Foam Windscreen
<b>A415DGWS</b>	Ball Grille Windscreen
<b>95E2313</b>	Storage Pouch

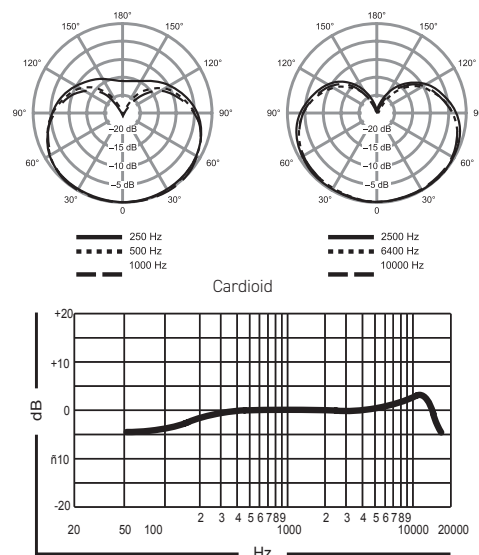

# MX396 MULTI-ELEMENT BOUNDARY MICROPHONES

Microflex Multi-Element Boundary Microphones deliver a unique and versatile tool for conference room installations. Clean and simple in appearance, Multi-Element Boundary mics come in two or three element configurations, combining the coverage of multiple microphones into one small, compact package.

## Specifications

<b>Type</b>	Condenser (electret bias)
<b>Frequency Response</b>	50 Hz - 17 kHz
<b>Output Impedance</b>	EIA rated at 150 Ω (170 Ω actual)
<b>Output Configuration</b>	Active balanced
<b>Sensitivity</b> at 1 kHz, open circuit voltage; 1 Pa = 94 dB SPL	-35 dBV/Pa (18 mV)
<b>Maximum SPL</b> 1 kHz at 1% THD, 1 kΩ load	122 dB
<b>Equivalent Output Noise</b> A-weighted	28 dB SPL
<b>Signal-to-Noise Ratio</b> referenced at 94 dB SPL at 1 kHz	66 dB
<b>Dynamic Range</b> 1 kΩ load at 1 kHz	94 dB
<b>Common Mode Rejection</b> 10 Hz to 100 kHz	45 dB minimum
<b>Preamplifier Output Clipping Level</b> 1% THD	-6 dBV (0.5 V)
<b>Weight</b>	Net: 587 g Packaged: 816 g
<b>Logic Connections</b>	LED IN: Active low (≤1.0 V), sinks up to 20 mA, TTL compatible. Absolute maximum voltage: -0.7 V to 50 V (up to 50 V through 3 kΩ). LOGIC OUT: Active low (≤1.0V), sinks up to 20 mA, TTL compatible. Absolute maximum voltage: -0.7 V to 50 V (up to 50 V through 3 kΩ).
<b>Mute Switch Attenuation</b>	-50 dB minimum
<b>Cable</b>	6 m attached unterminated cable with three shielded audio pairs and three shielded conductors for logic control.
<b>Environmental Conditions</b>	Operating temperature: -18 - 57 °C Storage temperature: -29 - 74 °C Relative humidity: 0 - 95%
<b>Power Requirements</b>	MX396/C-DUAL: 48 - 52 Vdc phantom, 10.0 mA MX396/C-TRI: 48 - 52 Vdc phantom, 12.0 mA

## Available Models

<b>MX396/C-DUAL</b>	Dual-Element 0-180 degrees, back or bottom exit cable, mute output, LED input
<b>MX396/C-TRI</b>	Tri-Element 90-0-90 mic, adjustable to 120-120-120 degrees, back or bottom exit cable, mute output, LED input

## Furnished Accessories and Replacement Parts

<b>65A2190</b>	Fastening wingnut	<b>R185B</b>	Cardioid replacement cartridge (x 1)
<b>31A2165</b>	Fastening tube	<b>65A405</b>	Rubber isolation rings



MX396 Multi-Element boundary microphone

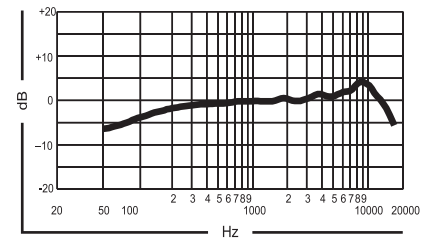
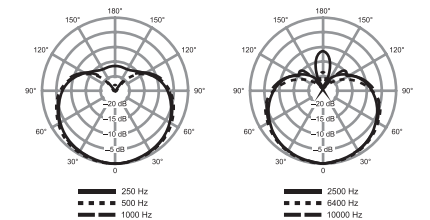

Example of Boardroom Table Mic Placement Coverage

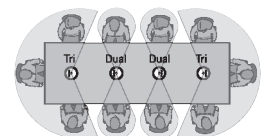

# MX395 LOW PROFILE BOUNDARY MICROPHONES

The Microflex Low Profile Boundary Microphone is an ideal table microphone when minimal presence is of high priority. Perfect for meeting rooms, these microphones deliver exceptional sound pickup while barely being noticed. Choose from a selection of colors and pickup patterns for customized table and ceiling installations.

## Specifications

<b>Type</b>	Condenser (electret bias)
<b>Frequency Response</b>	50 Hz - 17 kHz
<b>Polar Pattern</b>	MX395/O: Omnidirectional MX395/C: Cardioid MX395/BI: Bidirectional
<b>Output Impedance</b>	EIA rated at 150 Ω (170 Ω actual)
<b>Output Configuration</b>	Active balanced
<b>Sensitivity</b> at 1 kHz, open circuit voltage; 1 Pascal = 94 dB SPL	Cardioid: -35 dBV/Pa (18 mV) Omnidirectional: -28 dBV/Pa (42 mV) Bidirectional: -37 dBV/Pa (14 mV)
<b>Maximum SPL</b> 1 kHz at 1% THD, 1 kΩ load	Cardioid: 121 dB Omnidirectional: 114 dB Bidirectional: 123 dB
<b>Equivalent Output Noise</b> A-weighted	Cardioid: 28 dB SPL Omnidirectional: 21 dB SPL Bidirectional: 29 dB
<b>Signal-to-Noise Ratio</b> referenced at 94 dB SPL at 1 kHz	Cardioid: 66 dB Omnidirectional: 73 dB Bidirectional: 65 dB
<b>Dynamic Range</b> 1 kΩ load at 1 kHz	Cardioid: 93 dB Omnidirectional: 93 dB Bidirectional: 94 dB
<b>Common Mode Rejection</b>	45 dB minimum 10 Hz to 100 kHz
<b>Preamplifier Output Clipping Level</b> 1% THD	-8 dBV (0.4 V)
<b>Polarity</b>	3-pin XLR: Positive sound pressure on diaphragm produces positive voltage on pin 2 relative to pin 3 of output XLR connector. 5-pin XLR: Positive sound pressure on diaphragm produces positive voltage on pin 4 relative to pin 2 of output XLR connector.
<b>Weight</b>	Net: 136 g; Packaged: 374 g
<b>Logic Connections</b>	LED IN: Active low (≤ 1.0 V), TTL compatible. Absolute maximum voltage: -0.7 V to 50 V.
<b>Environmental Conditions</b>	Operating temperature: -18 - 57 °C Storage temperature: -29 - 74 °C Relative humidity: 0 - 95%
<b>Power Requirements</b>	MX395: 11 - 52 Vdc phantom, 2.0 mA MX395-LED: 48 - 52 Vdc phantom, 8.0 mA

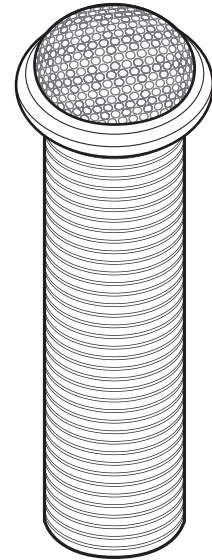

**MX395**  
Low Profile  
Boundary Mic

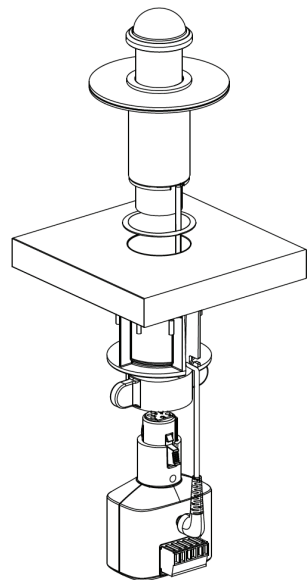

**MX395 with A400MB Mute Button**  
Exploded View

## Available Models

The polar pattern of the cartridge is indicated by the model number suffix: C = Cardioid, O = Omnidirectional, BI = Bidirectional

<b>MX395B/C, MX395B/BI, MX395B/O</b>	Black, 3-pin XLR
<b>MX395AL/C, MX395AL/BI, MX395AL/O</b>	Aluminum, 3-pin XLR
<b>MX395W/C, MX395W/BI, MX395W/O</b>	White, 3-pin XLR
<b>MX395B/C-LED, MX395B/BI-LED, MX395B/O-LED</b>	Black, 5-pin XLR, LED, bi-color status indicator
<b>MX395AL/C-LED, MX395AL/BI-LED, MX395AL/O-LED</b>	Aluminum, 5-pin XLR, LED, bi-color status indicator
<b>MX395W/C-LED, MX395W/BI-LED, MX395W/O-LED</b>	White, 5-pin XLR, LED, bi-color status indicator

## Optional Accessories

<b>A400MB</b>	Mute Button Accessory
<b>A400MB-MOUNT</b>	Remote Mounting Kit for A400MB

## Furnished Accessories

<b>65A405</b>	Rubber isolation rings
<b>95A1118 (LED Models only)</b>	5-pin XLR-female connector
<b>65A2190</b>	Wing nut

# MX395 LOW PROFILE BOUNDARY MICROPHONES

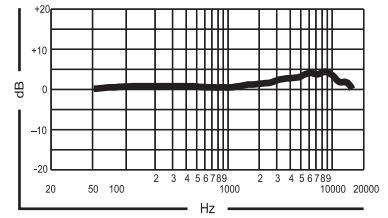
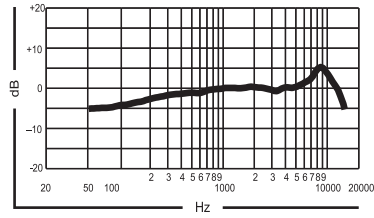
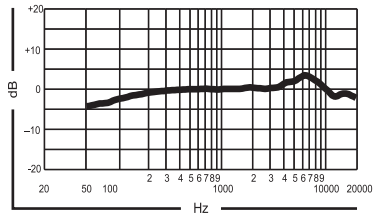
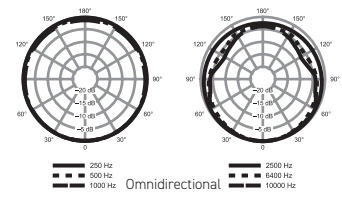
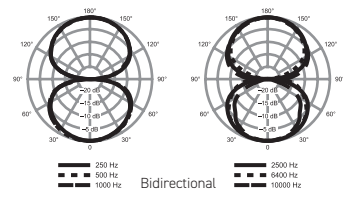
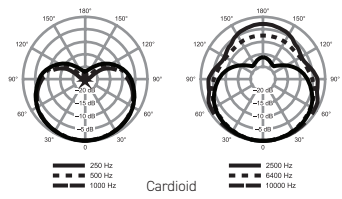

# MX202 OVERHEAD MICROPHONES

Easily hung from ceilings, Microflex Overhead Microphones capture sound from speakers, choirs, stages, and more conveniently and unobtrusively from above. Compact and flexible, overhead microphones each feature a 10 cm (4") gooseneck, multiple preamp options for easy installation into ceilings or microphone stands, and versatile condenser cartridges for accurate sound reproduction in any setting.

## Specifications

<b>Type</b>	Condenser (electret bias)
<b>Frequency Response</b>	50 Hz - 17 kHz
<b>Polar Pattern</b>	MX202/C: Cardioid MX202/O: Omnidirectional MX202/S: Supercardioid MX202/MS Lobar mini-shotgun
<b>Output Impedance</b>	150 Ω rated at EIA (180 Ω actual)
<b>Sensitivity</b> (at 1 kHz, open circuit voltage; 1 Pascal = 94 dB SPL)	Cardioid: -35.0 dBV/Pa (17.8 mV) Supercardioid: -33.5 dBV/Pa (21.1 mV) Omnidirectional: -27.5 dBV/Pa (42.2 mV) Lobar: -33 dBV/Pa (22 mV)a
<b>Maximum SPL</b> (1 kHz at 1% THD, 1 kΩ load; All values +6 dB at 0 gain)	Cardioid: 124.2 dB Supercardioid: 122.7 dB Omnidirectional: 116.7 dB Lobar: 121 dB SPL
<b>Equivalent Output Noise</b> A-weighted	Cardioid: 28.0 dB SPL Supercardioid: 26.5 dB SPL Omnidirectional: 20.5 dB SPL Lobar: 36 dB
<b>Signal to Noise Ratio</b> (referenced at 94 dB SPL)	Cardioid: 66.0 dB Supercardioid: 67.5 dB Omnidirectional: 73.5 dB Lobar: 68 dB
<b>Dynamic Range</b> 1 kΩ load at 1 kHz	96.2 dB 100 dB at 0 gain (internal modification)
<b>Common Mode Rejection</b> 10 Hz to 100 kHz	45 dB minimum
<b>Preamplifier Output Clipping Level</b> 1% THD	-6 dBV (0.5 V)
<b>Polarity</b>	Positive sound pressure on diaphragm produces positive voltage on pin 2 relative to pin 3 of output connector.
<b>Power Requirements</b>	11 - 52 Vdc phantom, 2.0 mA
<b>Environmental Requirements</b>	Operating temperature range: -18° C - 57° C Relative humidity: 0 - 95%
<b>Cable Length</b>	30 feet (9.1 m)
<b>Termination</b>	TA4F 4-socket female (in-line preamp models); bare ends (plate-mounted preamp models)

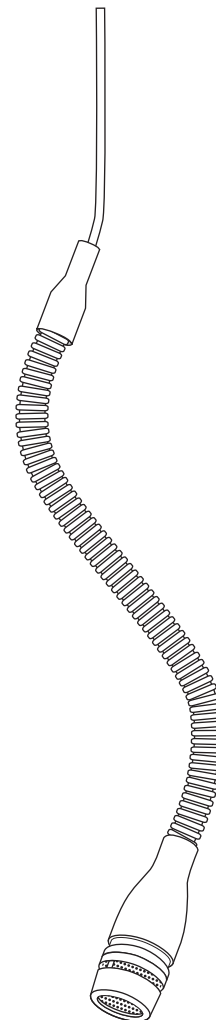

**MX202**  
Overhead Microphone

## Available Models

The polar pattern of the cartridge is indicated by the model number suffix: C = Cardioid, S = Supercardioid, N = No Cartridge, MS = Lobar

<b>MX202B/C, /S, /N, /MS</b>	Black mini-condenser microphone; includes cable, in-line preamplifier, and stand adapter
<b>MX202W-A/C, /S, /N, /MS</b>	Bright white mini-condenser microphone; includes cable, in-line preamplifier, and stand adapter
<b>MX202BP/C, /S, /N, /MS</b>	Black mini-condenser microphone; includes cable and plate-mounted preamplifier
<b>MX202WP-A/C, /S, /N, /MS</b>	Bright white mini-condenser microphone; includes cable and plate-mounted preamplifier

# MX202 OVERHEAD MICROPHONES

## Furnished Accessories

<b>RK183WS (Black)</b> <b>95B2064 (White)</b>	Black snap-fit foam windscreen White snap-fit foam windscreen	<b>65B1752</b>	Stand adapter (MX202B)
<b>RK202PK</b>	Preamplifier kit, plate mounted, White (MX202BP & MX202WP)	<b>RK100PK/ RK100KW</b>	In-line preamplifier (MX202W & MX202B)
<b>80A476</b>	Clamp (MX202B & MX202WP)	<b>80B489</b>	Hang clip
<b>A189BWS</b>	Black snap fit windscreen for R189	<b>A189WWS</b>	Bright white snap fit windscreen for R189

## Optional Accessories and Replacement Parts

<b>A202BB</b>	Desk stand	<b>R184B (Black)</b> <b>R184W-A (White)</b>	Supercardioid cartridge for all Microflex models
<b>80A479</b>	Strain relief (MX202BP & MX202WP)	<b>R185B (Black)</b> <b>R185-A (White)</b>	Cardioid cartridge for all Microflex models
<b>R189B</b>	(Black) mini-shotgun cartridge for all Microflex Models	<b>R189W</b>	(White) mini-shotgun cartridge for all Microflex Models
<b>R183B (Black)</b> <b>R183W-A (White)</b>	Omnidirectional cartridge for all Microflex models		

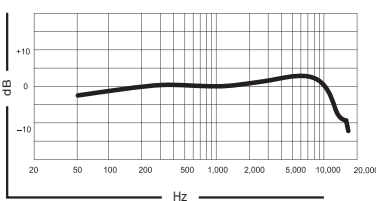
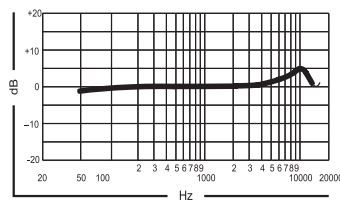
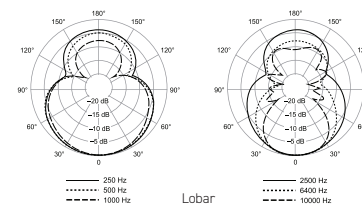
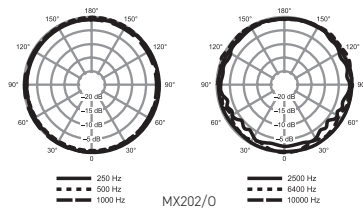
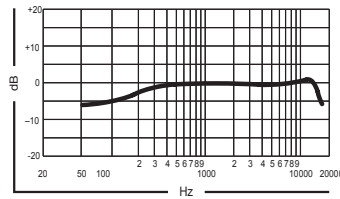
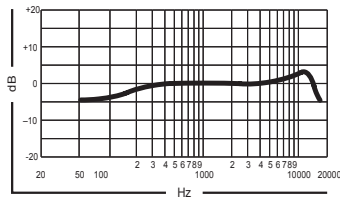
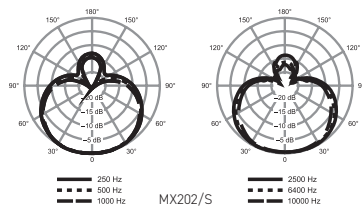
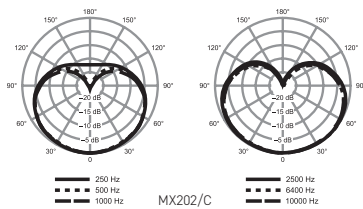

# MX391, MX392, MX393 BOUNDARY MICROPHONES

With slim design and superior audio reproduction, Microflex Boundary Microphones are the ideal conference room solution. Equipped with features like programmable, silent membrane switches, interchangeable cartridges, logic inputs and outputs, and LED indicators, Microflex Boundary microphones provide high-quality sound for a wide range of applications.

## Specifications

<b>Type</b>	Condenser (electret bias)	
<b>Frequency Response</b>	50 Hz – 17 kHz	
<b>Polar Pattern</b>	MX391/C, MX392/C, MX392BE/C, MX393/C: Cardioid MX391/S, MX392BE/S, MX392/S, MX393/S: Supercardioid MX391/O, MX392/O, MX392BE/O, MX393/O: Omnidirectional	
<b>Output Impedance</b>	EIA rated at 150 Ω (180 Ω actual)	
<b>Logic Connections</b> (MX392 Only)	LED IN: Active low (≤1.0 V), TTL compatible. Absolute maximum voltage: -0.7 V to 50 V. SWITCH OUT: Active low (≤0.5 V), sinks up to 20 mA, TTL compatible. Absolute maximum voltage: -0.7 V to 50 V (up to 50 V through 3 kΩ).	
<b>Environmental Conditions</b>	Operating temperature range: -18° C – 57° C Relative Humidity: 0 – 95%	
<b>Power Requirements</b>	11 – 52 Vdc phantom, 2.0 mA	
	<b>MX391</b>	<b>MX392/MX393</b>
<b>Sensitivity</b> (at 1 kHz, open circuit voltage; 1 Pascal = 94 dB SPL); All settings -12 dB at 0 gain (internal modification)	Cardioid: -29.5 dB (33.5 mV) Supercardioid: -28.3 dB (38.5 mV) Omnidirectional: -21.8 dB (81.4 mV)	Cardioid: -27.5 dBV/Pa (42.2 mV) Supercardioid: -26.5 dBV/Pa (47.3 mV) Omnidirectional: -22.0 dBV/Pa (79.4 mV)
<b>Maximum SPL</b> 1 kHz at 1% THD, 1 kΩ load; All settings +6 dB at 0 gain (internal modification)	Cardioid: 118.8 dB Supercardioid: 117.5 dB Omnidirectional: 110.7 dB	Cardioid: 117.0 dB Supercardioid: 116.0 dB Omnidirectional: 111.5 dB
<b>Equivalent Output Noise</b> A-weighted	Cardioid: 22.6 dB SPL Supercardioid: 21.3 dB SPL Omnidirectional: 14.5 dB SPL	Cardioid: 23.0 dB Supercardioid: 22.0 dB Omnidirectional: 17.5 dB
<b>Signal-to-Noise Ratio</b> referenced at 94 dB SPL at 1 kHz	Cardioid: 71.4 dB Supercardioid: 72.7 dB Omnidirectional: 79.5 dB	Cardioid: 71.0 dB Supercardioid: 72.0 dB Omnidirectional: 76.5 dB
<b>Dynamic Range</b> 1 kΩ load at 1 kHz	96.2 dB	94.0 dB
<b>Common Mode Rejection</b> 10 Hz to 100 kHz	45 dB minimum, 10 Hz to 100 kHz	45 dB minimum, 10 Hz to 100 kHz
<b>Preamplifier Output Clipping Level</b> 1% THD	-6 dBV (0.5 V)	-6 dBV (0.5 V)
<b>Polarity</b>	Positive sound pressure on diaphragm produces positive voltage on pin 2 relative to pin 3 of the preamplifier XLR output	Positive sound pressure on diaphragm produces positive voltage on pin 2 relative to pin 3 of output connector (MX393) or red wire relative to black wire (MX392).

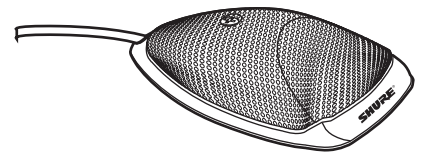

**MX391**  
Boundary Microphone



**MX393**  
Boundary Microphone with LED and switch

## Available Models

The polar pattern of the cartridge is indicated by the model number suffix: C = Cardioid, O = Omnidirectional, S = Supercardioid

<b>MX391/C, MX391/S, MX391/O</b>	Black surface-mount microphone, attached 3.7 m cable terminated, 4-pin mini connector, separate preamplifier
<b>MX391W-A/C, /S, /O</b>	Bright white surface-mount microphone, attached 3.7 m cable terminated, 4-pin mini connector, separate preamplifier
<b>MX392/C, MX392/S, MX392/O</b>	Surface-mount microphone, programmable membrane on/off switch, logic input/output terminals, on/off indicator LED, screw terminal connections, attached 3.7 m unterminated cable, rear exit
<b>MX393/C, MX393/S, MX393/O</b>	Surface-mount microphone, programmable membrane on/off switch, on/off indicator LED, miniature three pin connector, and detachable 3.7 m cable.
<b>MX392BE/C, MX392BE/S, MX392BE/O</b>	Surface-mount microphone, programmable membrane on/off switch, logic input/output terminals, on/off indicator LED, screw terminal connections, attached 3.7m unterminated cable, bottom exit



# MX391, MX392, MX393 BOUNDARY MICROPHONES

## Furnished Accessories

<b>95B2313</b>	Zipper bag	<b>80A541</b>	Switch paint mask (MX392/MX393)
<b>80C514</b>	Paint mask (MX392/MX393)	<b>36A664</b>	Paint plug (MX392/MX393)
<b>RK100PK</b>	In-line preamp (MX391/MX391W)		

## Optional Accessories and Replacement Parts

<b>R183B</b>	Omnidirectional cartridge for all Microflex models	<b>C129</b>	3,7 m cable 3-pin miniature connector (TA3F) to male XLR (MX393)
<b>R184B</b>	Supercardioid cartridge for all Microflex models	<b>C130</b>	Custom-logic cable with threaded adapter
<b>R185B</b>	Cardioid cartridge for all Microflex models	<b>15A525</b>	Custom logic cable (specify length)

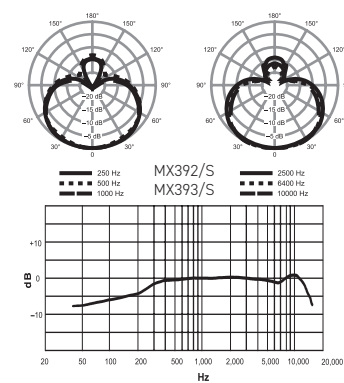
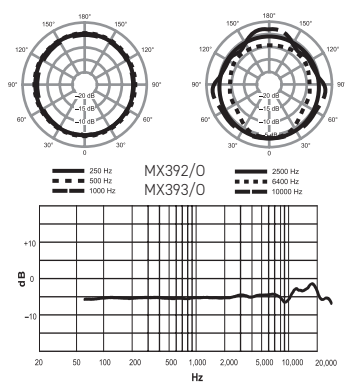
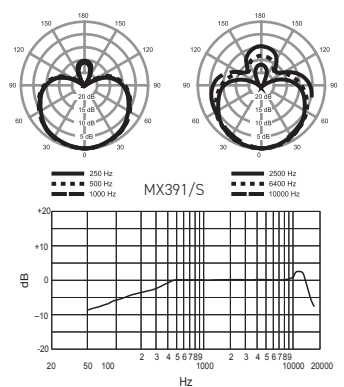
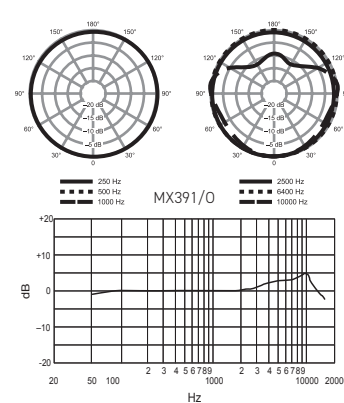
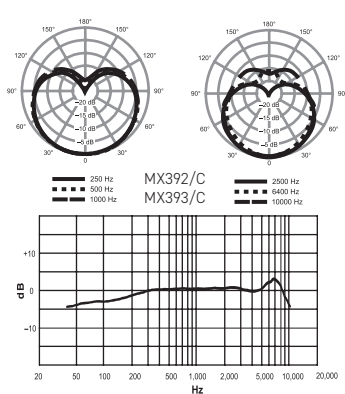
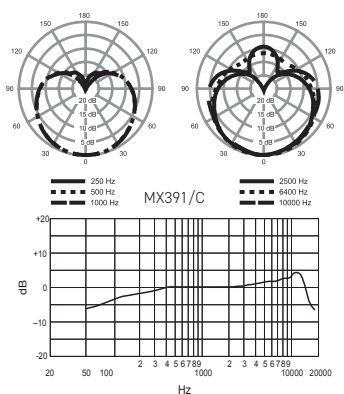

# MX150 SUBMINIATURE CONDENSER LAVALIER MICROPHONE

The Shure Microflex MX150 is a professional subminiature electret condenser lavalier microphone ideal for use in speech and other applications requiring low profile, discreet placement. Available with cardioid or omnidirectional patterns, the MX150 provides uncompromised sound quality and high reliability with minimal visibility for use in television broadcasting, corporate and educational lectures, A/V teleconferencing, and sound reinforcement.

## Features

- Available in cardioid or omnidirectional polar patterns and TQG/TA4F (for use in Shure bodypacks) or wired XLR variations
- CommShield® technology guards against interference from cellular RF devices and digital bodypack transmitters
- Matte black, sleek, low-profile, design for inconspicuous placement
- Multi-position tie clip allows for a variety of placement options and features an integrated cable management system for convenient cable dress with minimized handling noise.
- Kevlar-reinforced soft-flex cable design further reduces handling noise while providing superior flexibility for routing and placement
- User-changeable equalization caps for response shaping (omnidirectional only)
- Snap-fit, concise windscreens provides protection from plosives and wind noise with minimal visibility
- Legendary Shure quality, ruggedness, and reliability

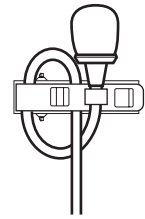

MX150 with tie clip and windscreen

## Available Models

<b>MX150B/O-TQG</b>	Microflex subminiature condenser lavalier microphone, omnidirectional, TQG connector
<b>MX150B/C-TQG</b>	Microflex subminiature condenser lavalier microphone, cardioid, TQG connector
<b>MX150B/O-XLR</b>	Microflex subminiature condenser lavalier microphone, omnidirectional, XLR connector
<b>MX150B/C-XLR</b>	Microflex subminiature condenser lavalier microphone, cardioid, XLR connector

## Specifications

	MX150/C	MX150/O
<b>Transducer Type</b>	Electret condenser	Electret condenser
<b>Polar Pattern</b>	Cardioid	Omnidirectional
<b>Frequency Response</b>	20 - 20 kHz	20 - 20 kHz
<b>Output Impedance</b>	TQG: N/A, XLR: 165.5 Ω	TQG: N/A, XLR: 165.0 Ω
<b>Sensitivity</b> open circuit voltage, @ 1 kHz, typical	TQG: -51.0 dBV/Pa (3.0 mV) XLR: -39.0 dBV/Pa (11.0 mV)	TQG: -46.5 dBV/Pa (4.5 mV) XLR: -34.5 dBV/Pa (19.0 mV)
<b>Maximum SPL</b> 1 kHz at 1% THD, 2500 Ω Load	TQG: 147.5 dB SPL XLR: 134.5 dB SPL	TQG: 143.0 dB SPL XLR: 130 dB SPL
<b>Signal-to-Noise Ratio</b>	TQG: 57.5 dB XLR: 57.0 dB	TQG: 60.0 dB XLR: 59.5 dB
<b>Clipping Level</b> 1 kHz at 1% THD, 2500 Ω Load	TQG: 2.0 dBV XLR: 1.0 dBV	TQG: 2.0 dBV XLR: 1.0 dBV
<b>Common Mode Rejection</b> 20 Hz - 20 kHz	TQG: N/A XLR: >60 dB	TQG: N/A XLR: >60 dB
<b>Dynamic Range</b> @ 1 kHz, 2500 Ω Load	TQG: 111.0 dB SPL XLR: 97.5 dB SPL	TQG: 109.0 dB SPL XLR: 95.5 dB SPL
<b>Self Noise</b> equivalent SPL, A-weighted, typical	TQG: 36.5 dB XLR: 37.0 dB	TQG: 34.0 dB XLR: 34.5 dB
<b>Operating Temperature Range</b>	-18°C to 57°C	-18°C to 57°C
<b>Polarity</b>	TQG: Positive pressure on diaphragm produces positive voltage on pin 3 with respect to pin 1 XLR: Positive pressure on diaphragm produces positive voltage on pin 2 with respect to pin 3	
<b>Power Requirements</b>	TQG: 5 V DC (0.04 - 0.18 mA) XLR: 11-52 V DC phantom power (IEC-61938), < 2.2 mA	TQG: 5 V DC (0.04 - 0.18 mA) XLR: 11-52 V DC phantom power (IEC-61938), < 2.2 mA
<b>Cable Length</b>	1.52 m	1.52 m
<b>Weight</b>	TQG: 21 g XLR: 121 g	TQG: 21 g XLR: 121 g

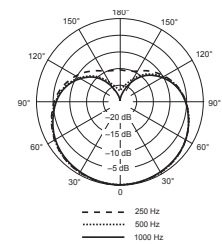
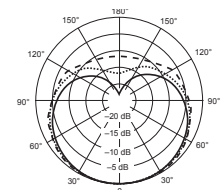

MX150/C Polar Pattern

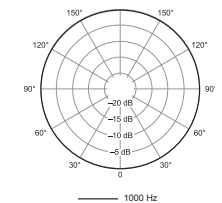

MX150/O Polar Pattern

## Accessories

<b>WA150</b>	Storage pouch for MX150
<b>WA330</b>	TQG/TA4F 4 pin connector
<b>RK100PK</b>	XLR preamp

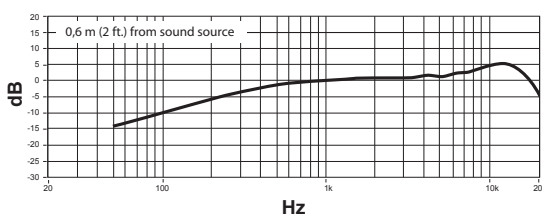

MX150/C Frequency Response

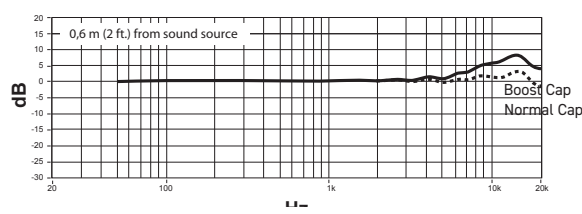

MX150/O Frequency Response



# MX153 EARSET HEADWORN MICROPHONE

The Shure Microflex MX153 is a professional subminiature earset microphone ideal for speech and other applications requiring low-profile discreet placement where improved gain before feedback over lavalier microphones is desired. Delivering exceptional speech clarity, the MX153 is ideal for corporate and educational presentations, A/V conferencing and live sound reinforcement. Available in three color options and direct TA4F connectivity to Shure bodypacks, the MX153 provides outstanding clarity in an extremely comfortable, over the ear design.

## Features

- Subminiature, omnidirectional cartridge offers superior speech clarity and enhanced plosive protection with no proximity effect
- Terminated with TQG/TA4F connector for direct connectivity to Shure wireless bodypack transmitters
- Ultra-lightweight, comfortable, flexible design is stable and easy to place over either ear
- CommShield® technology guards against interference from cellular RF devices and digital bodypack transmitters
- Kevlar reinforced, attached soft-flex cable
- Matte black, tan, and cocoa color options available
- Includes protective storage pouch, 3 windscreens, and collar clip

## Available Models

<b>MX153B/O-TQG</b>	Microflex earset headworn condenser microphone, omnidirectional, TQG connector, black
<b>MX153T/O-TQG</b>	Microflex earset headworn condenser microphone, omnidirectional, TQG connector, tan
<b>MX153C/O-TQG</b>	Microflex earset headworn condenser microphone, omnidirectional, TQG connector, cocoa

## Specifications

	<b>MX153</b>
<b>Transducer Type</b>	Electret condenser
<b>Polar Pattern</b>	Omnidirectional
<b>Frequency Response</b>	20 Hz - 20 kHz
<b>Output Impedance</b>	N/A
<b>Sensitivity</b> open circuit voltage, @ 1 kHz, typical	-41 dBV/Pa (9 mV)
<b>Maximum SPL</b> 1 kHz at 1% THD	2500 Ω load: 107 dB SPL 1000 Ω load: 107 dB SPL
<b>Signal-to-Noise Ratio</b>	60 dB
<b>Dynamic Range</b> @ 1 kHz	2500 Ω load: 73 dB 1000 Ω load: 73 dB
<b>Common Mode Rejection</b> 20 Hz - 20 kHz	N/A
<b>Self Noise</b> equivalent SPL, A-weighted, typical	34 dB
<b>Operating Temperature Range</b>	-18°C - 57°C
<b>Polarity</b>	Positive pressure on diaphragm produces negative voltage on pin 3 with respect to pin 1
<b>Power Requirements</b>	+1-5 V DC (500 µA maximum)
<b>Weight</b>	19.8 g

## Accessories

<b>WA150</b>	Storage pouch for MX150
<b>WA330</b>	TQG/TA4F 4 pin connector
<b>RK100PK</b>	XLR preamp

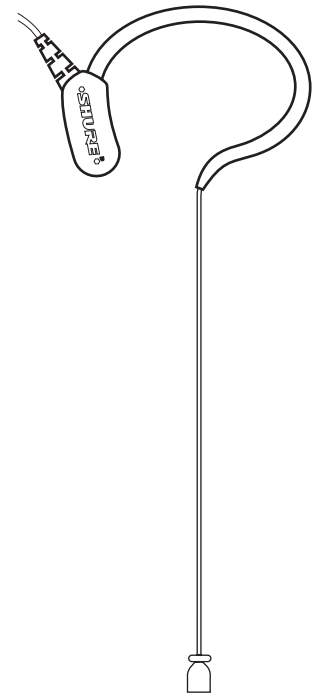
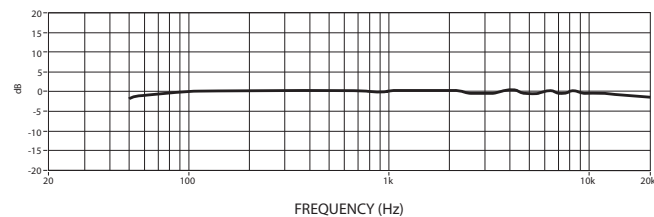

**MX153** Earset  
Headworn Microphone

# MX183, MX184, MX185 LAVALIER MICROPHONES

Attached to a tie or lapel, Microflex Lavalier Microphones offer freedom of movement to any situation involving voice reproduction. As stylish as they are convenient, Lavaliers are available in different directional patterns, come with multiple clip options, and are compatible with all Shure wireless platforms.

## Specifications

<b>Type</b>	Condenser (electret bias)
<b>Frequency Response</b>	50 Hz - 17 kHz
<b>Polar Pattern</b>	MX183: Omnidirectional MX184: Supercardioid MX185: Cardioid
<b>Output Impedance</b>	EIA rated at 150 $\Omega$ (170 $\Omega$ actual)
<b>Sensitivity</b> (at 1 kHz, open circuit voltage; 1 Pascal = 94 dB SPL; all settings -12 dB at 0 gain)	MX183: -27.5 dB (42.2 mV) MX184: -33.5 dB (21.1 mV) MX185: -35.4 dB (17.0 mV)
<b>Maximum SPL</b> (1 kHz at 1% THD, 1 k $\Omega$ load; all settings +6 dB at 0 gain)	MX183: 116.7 dB MX184: 122.7 dB MX185: 124.2 dB
<b>Equivalent Output Noise</b> A-weighted	MX183: 20.5 dB MX184: 26.5 dB MX185: 28.0 dB
<b>Signal-to-Noise Ratio</b> referenced at 94 dB SPL at 1 kHz	MX183: 73.5 dB MX184: 67.5 dB MX185: 66.0 dB
<b>Dynamic Range</b> 1 k $\Omega$ load at 1 kHz	96.2 dB 100 dB at 0 gain (internal modification)
<b>Common Mode Rejection</b> 10 Hz to 100 kHz	45 dB minimum
<b>Polarity</b>	Positive sound pressure on diaphragm produces positive voltage on pin 2 relative to pin 3 of output XLR connector.
<b>Environmental Conditions</b>	Operating temperature range: -18° - 57° C Storage temperature range: -29° - 74° C
<b>Power Requirements</b>	11 - 52 Vdc phantom, 2.0 mA
<b>Cable</b>	Shielded 1.2 m cable terminated with a 4-pin female mini connector (TA4F)

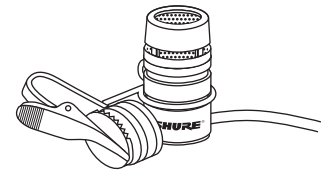

**MX183/ MX184/ MX185**  
Lavalier microphone

## Available Models

<b>MX183</b>	Omnidirectional, includes belt-clip preamp, rotatable tie clip, dual tie clip, snap-fit windscreen
<b>MX184</b>	Supercardioid, includes belt-clip preamp, rotatable tie clip, dual tie clip, snap-fit windscreen
<b>MX185</b>	Cardioid, includes belt-clip preamp, rotatable tie clip, dual tie clip, snap-fit windscreen

# MX183, MX184, MX185 LAVALIER MICROPHONES

## Furnished Accessories

<b>26A13</b>	Zipper bag	<b>RK183T1</b>	Tie clip
<b>RK261BWS</b>	Foam windscreen	<b>RK183T2</b>	Dual tie clip
<b>RK183WS</b>	Snap-fit windscreen	<b>RK100PK</b>	In-line preamp
<b>80A67</b>	Hex wrench #4		

## Optional Accessories and Replacement Parts

<b>R183B</b>	(Black) Omnidirectional cartridge for all Microfex models	<b>R184B</b>	(Black) Supercardioid cartridge for all Microfex models
<b>R185B</b>	(Black) Cardioid cartridge for all Microfex models	<b>MX1BP</b>	Battery powered preamp
<b>53A2133A</b>	Belt clip for in-line preamp	<b>WA333</b>	4-pin female mini connector (TA4F)
<b>C133</b>	Replacement cable, Microphone to preamp		

